

FIRMAN POWER EQUIPMENT

MODEL P03607, REV LEVEL: 01

Grounding System (AC): Neutral Bonded To Frame

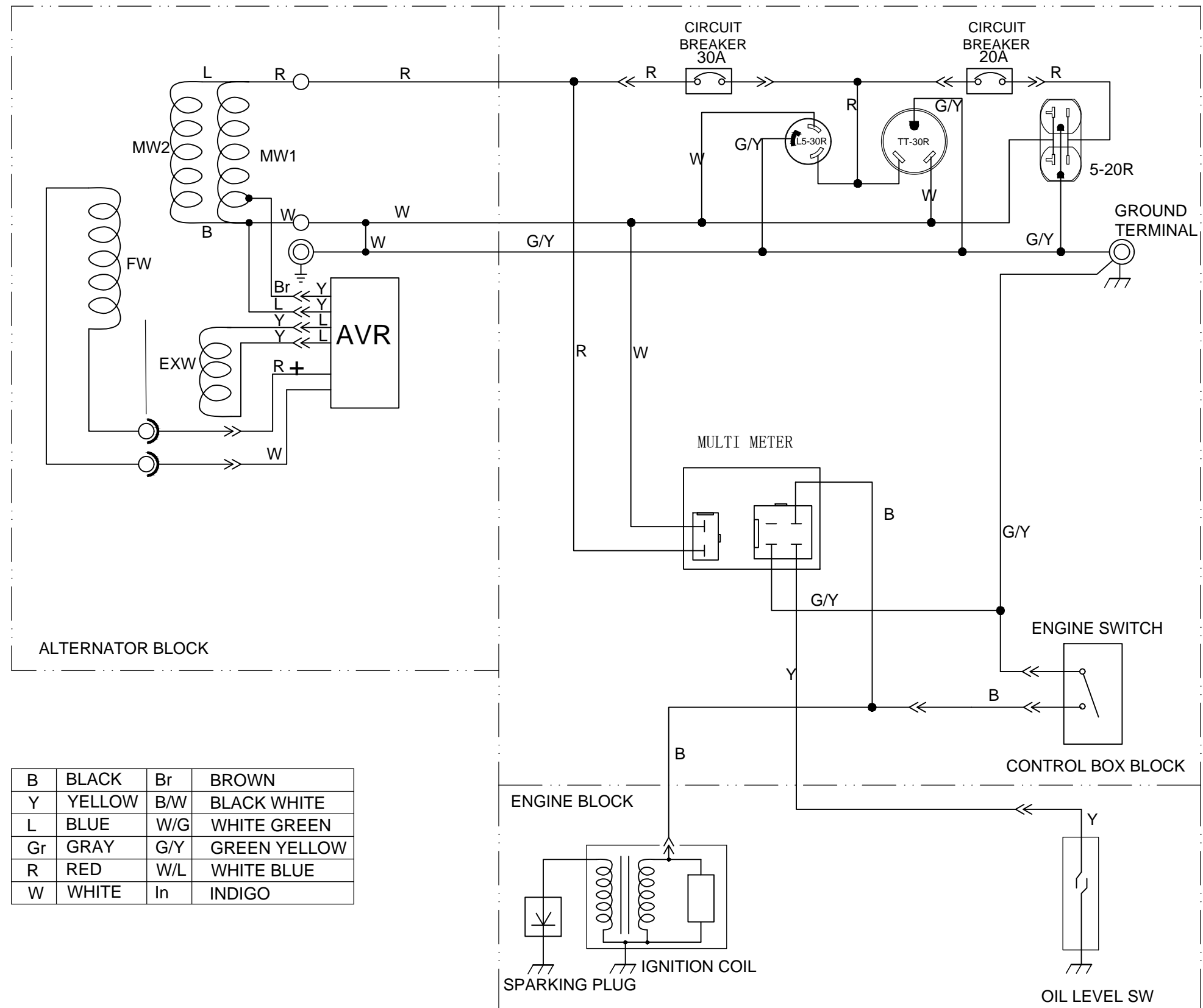

P/N	33600019
REVISION	01